

## What's inside a X-Phaser

July 2<sup>nd</sup> 2011  
Matthias Bopp

A colleague borrowed me his X-Phaser for some tests and I also had a look inside the unit.

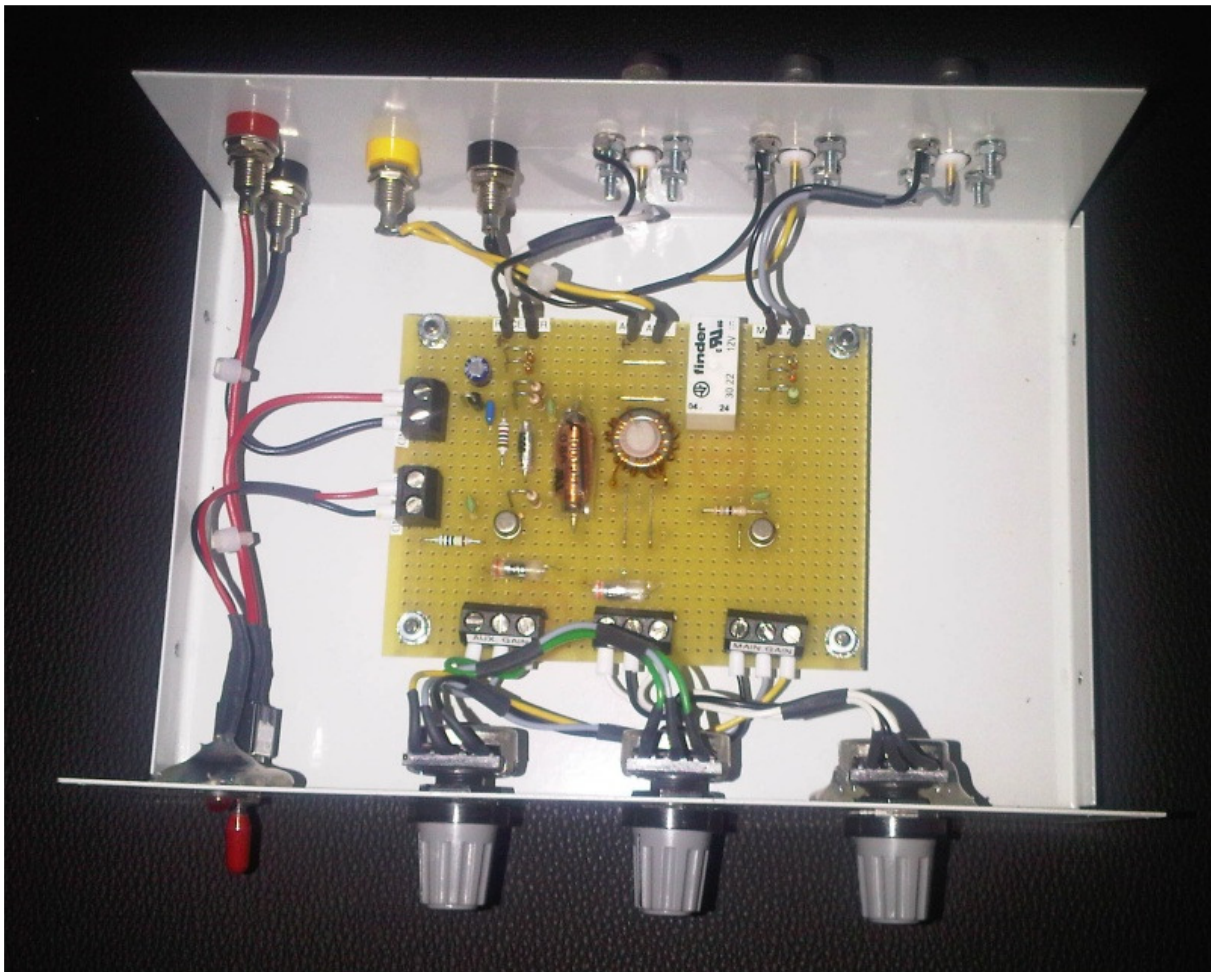



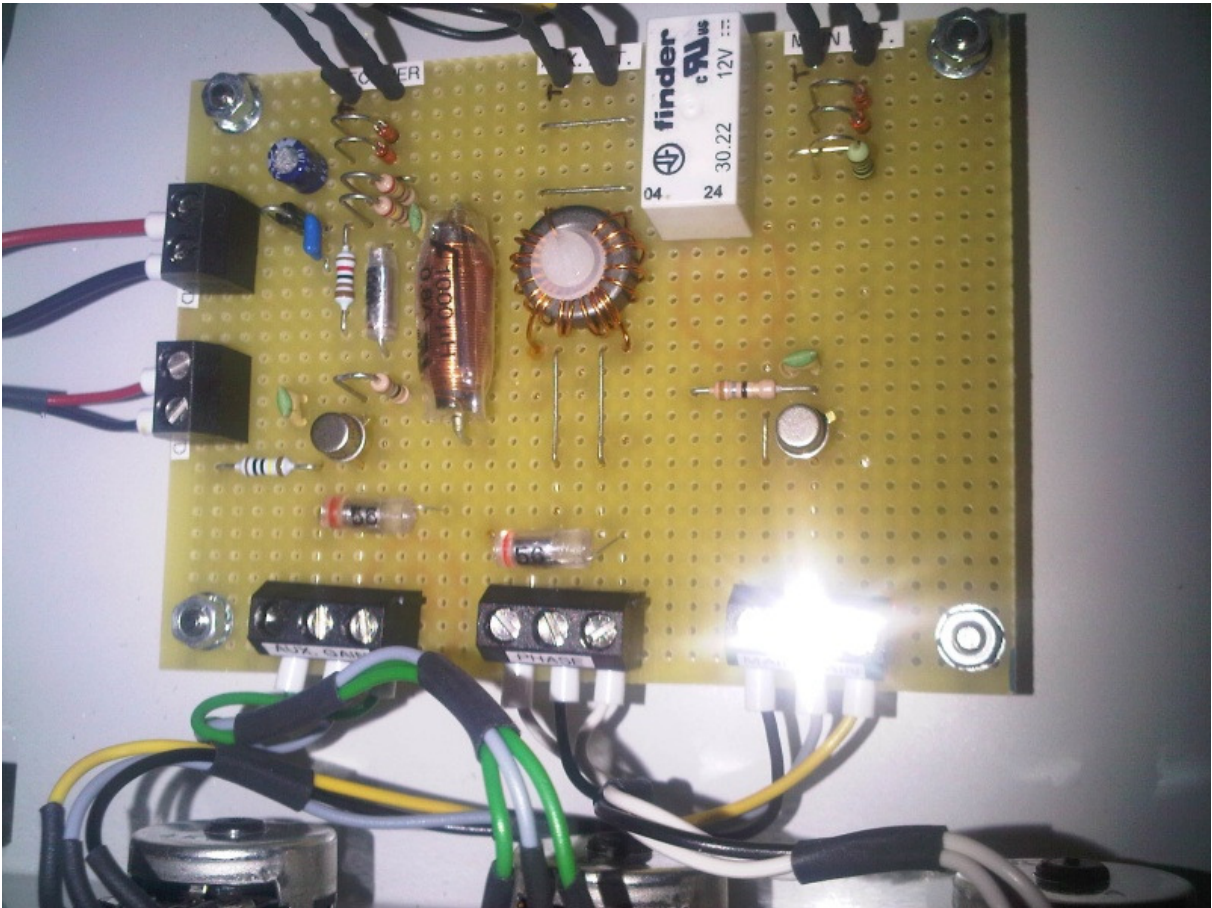
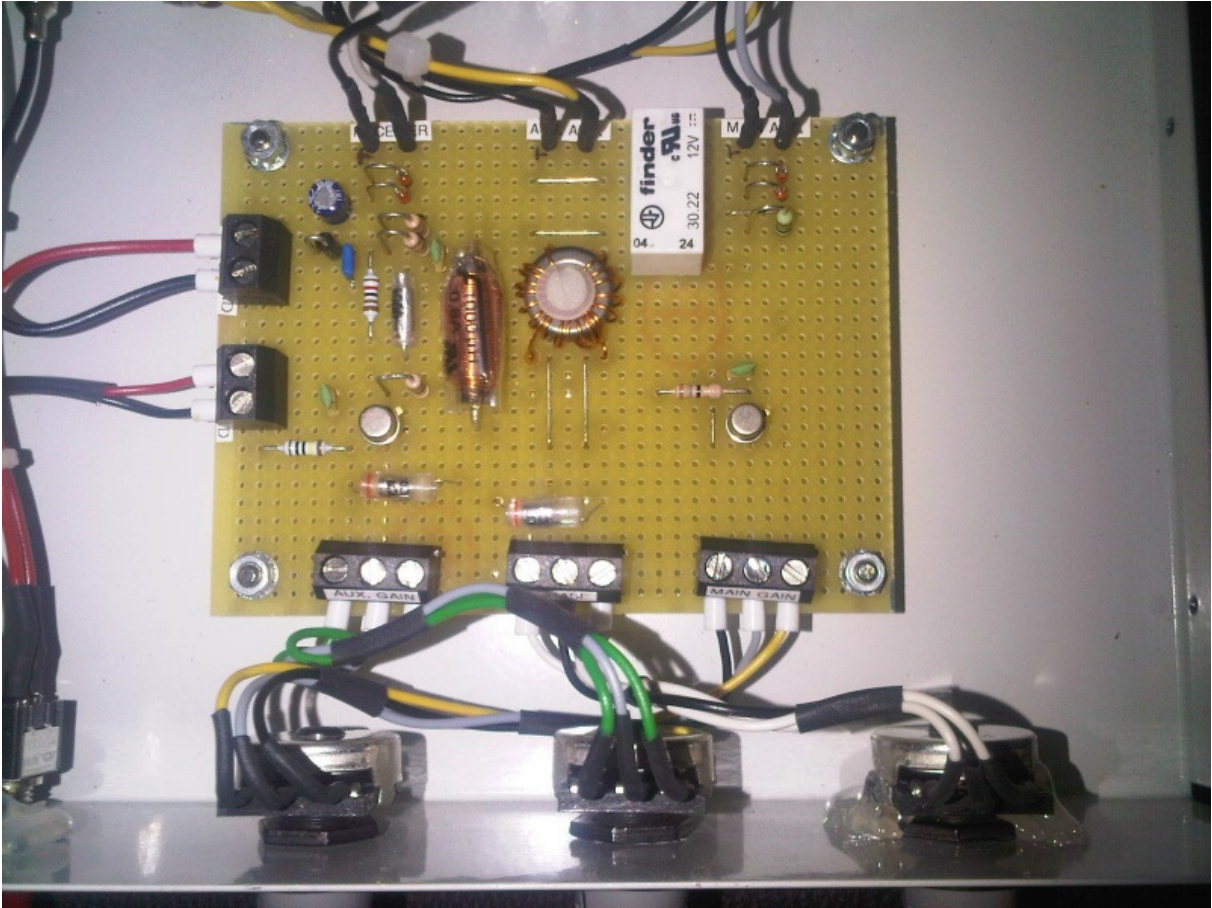



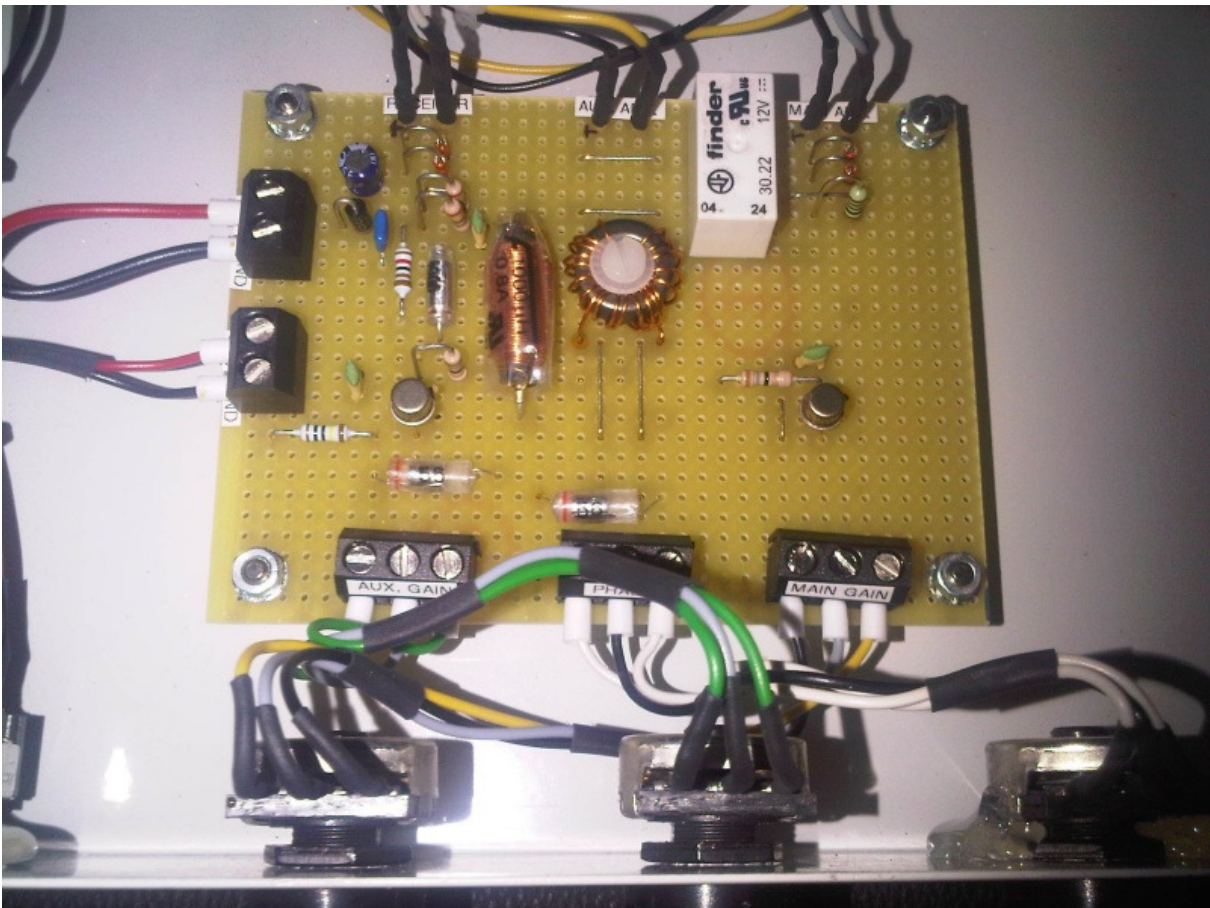
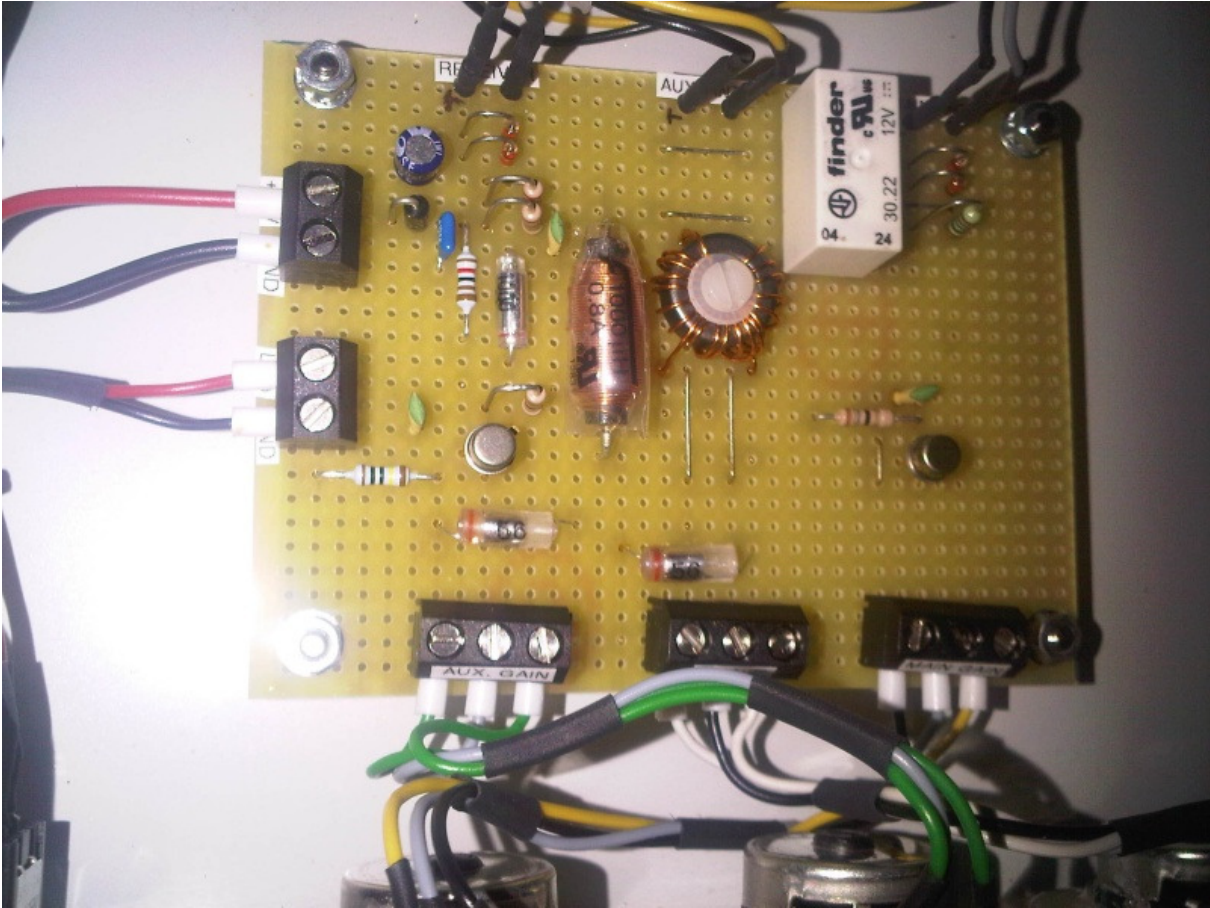



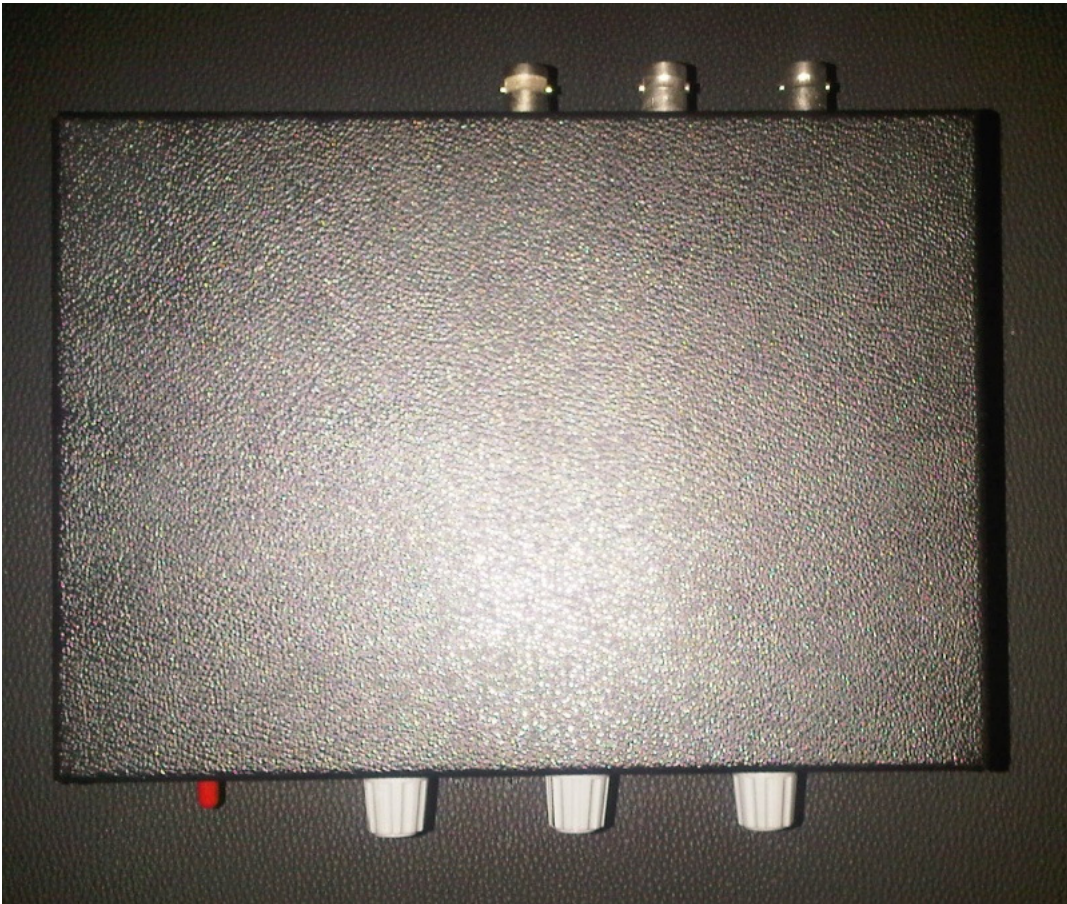
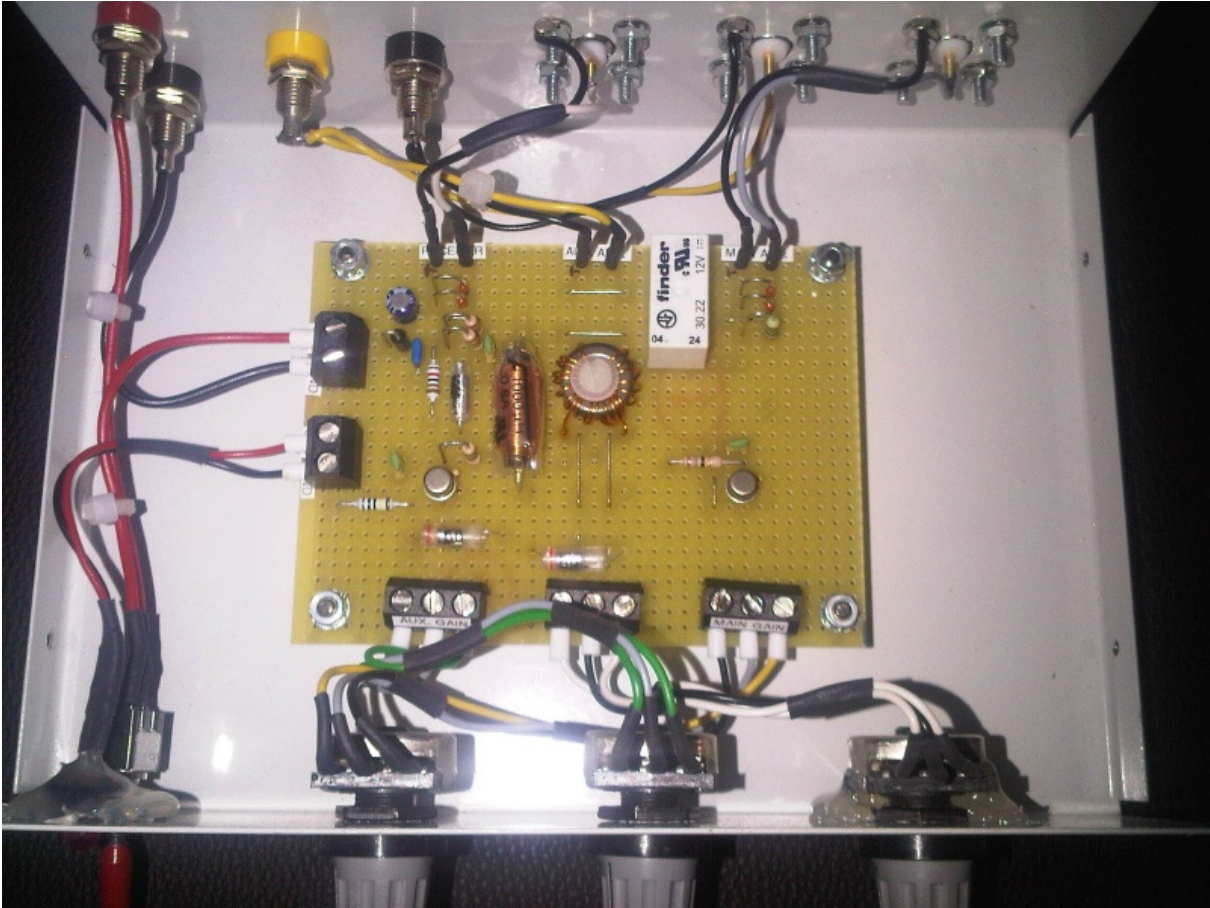

# X-PHASER

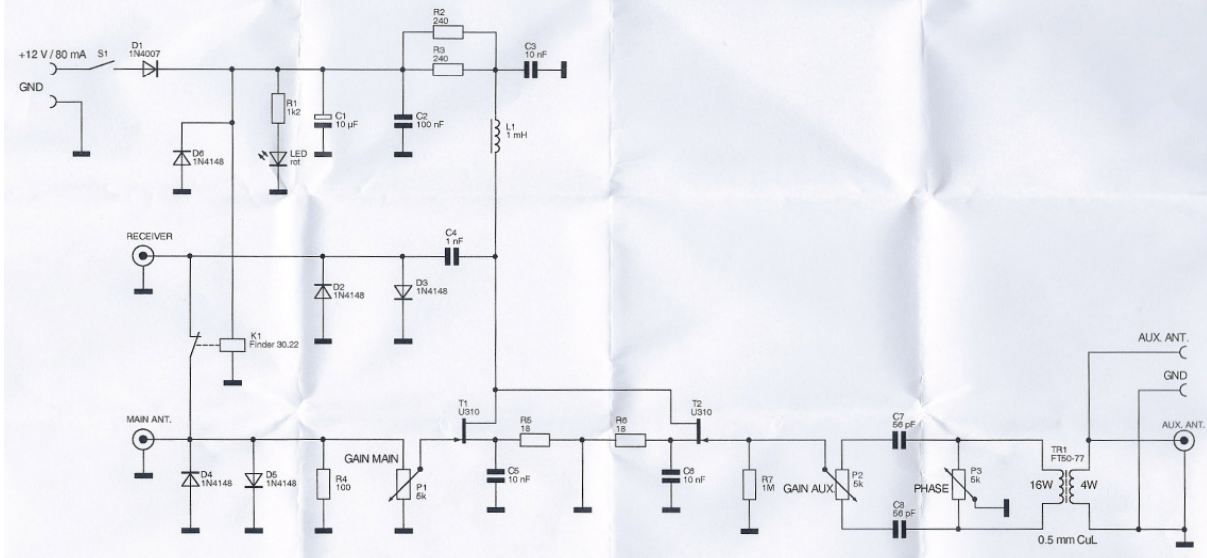

Comments and questions are always welcome, please send them to the Email address given below.

Best regards

Matthias

dd1us(at)amsat.org

[www.dd1us.de](http://www.dd1us.de)